

Revised May 31st 7:30 PM

Spirit Classic AFA National Qualifier
Antimi Complex in Cosmo Park, Columbia, Missouri
573-499-9741 - Rain Hotline

The 4:30 Games from Saturday will resume at 9:00 AM on Sunday
Sunday Games will have 1 hour time limit.
Championship Games will have 75 Minute Time Limit

Sunday	Sunday, June 1st					
	Antimi Purple	Antimi Blue	Antimi Red	Antimi Green	Antimi Gold	Antimi Black
9:00	14u Gm 3	10u Gm 3	14u Gm 4	16A/18B Gm 2	16B/18B Gm 3	18A Gm 3
10:15	12u Gm 5	10u Gm 4	12u Gm 6	16A/18B Gm 3	16B/18B Gm 4	18A Gm 4
11:30	14u Gm 5	10u Gm 5	14u Gm 6	16A/18B Gm 4	16B/18B Gm 5	18A Gm 5
12:45	12u Gm 9	10u Gm 6	16A/18B Gm 5	16A/18B Gm 6	16A/18B Gm 9	18A Gm 6
2:00	12u Gm 7	10u Gm 7	14u Gm 7	12u Gm 8	16B/18B Gm 6	18A Gm 7
3:15	12u Gm 10	10u Gm 8	14u Gm 8	16A/18B Gm 7	16A/18B Gm 8	18A Gm 8
4:30	12u Gm 11	10u Gm 9	14u Gm 9	16A/18B Gm 10	16B/18B Gm 7	18A Gm 9
5:45	12u Gm 12	10u Gm 10	14u Gm 10	16A/18B Gm 11	16B/18B Gm 8	18A Gm 10
7:00	12U if	10U if	14U if	16A/18B Gm 12	16B/18B if	18A if
8:15	X	X	X	16A/18B if	X	X

Pool A - 10U

- 1 Rockers-Jameson
- 2 Missouri Heat
- 3 Missouri Outburst
- 4 Missouri Warcats
- 5 Lady Jays

Pool B - 12U

- 1 Missouri Pride
- 2 Rockers-Bass
- 3 Club Elite Classics
- 4 Mid-Mo Cobras
- 5 Mid Mo Blaze
- 6 Fury

Pool C - 14U

- 1 Silver Streaks
- 2 Missouri Thunder 12u
- 3 Mid-Mo Eclipse
- 4 Fired Up
- 5 Rockers-Atwell

Pool D - 16B/18B 40'

- 1 Mid-Mo Renegades
- 2 HAVOC
- 3 Rockers-Perrigo
- 4 Mid-Missouri Blaze

Pool E - 16A/18B 40'

- 1 Silver Streaks
- 2 Rockers-Bunch
- 3 Rockers-Bildner
- 4 Mid-Mo Kaos
- 5 Missouri Pride
- 6 Hannibal Gold

Pool F - 18A 43'

- 1 St. Louis Esprit-K
- 2 Macon Travelers
- 3 Missouri Renegades Gold
- 4 Missouri Snappers
- 5 St. Louis Illusions-Bergman

5 Teams - 3 Game Guarantee Bracket

Winner's Bracket

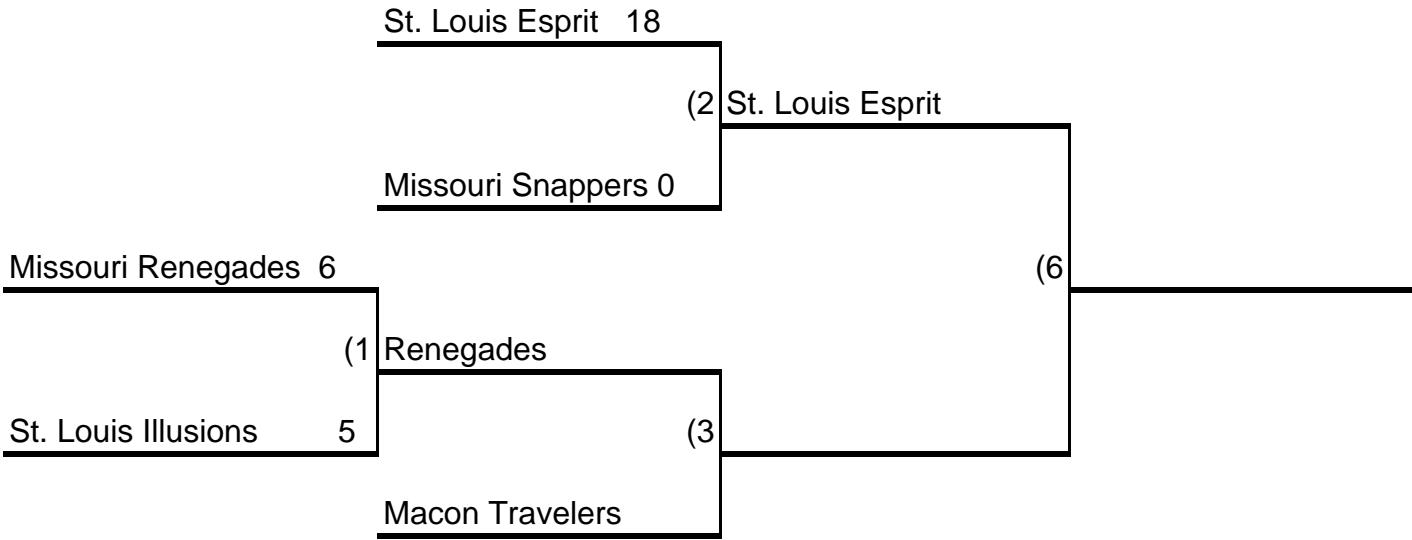

Loser's Bracket

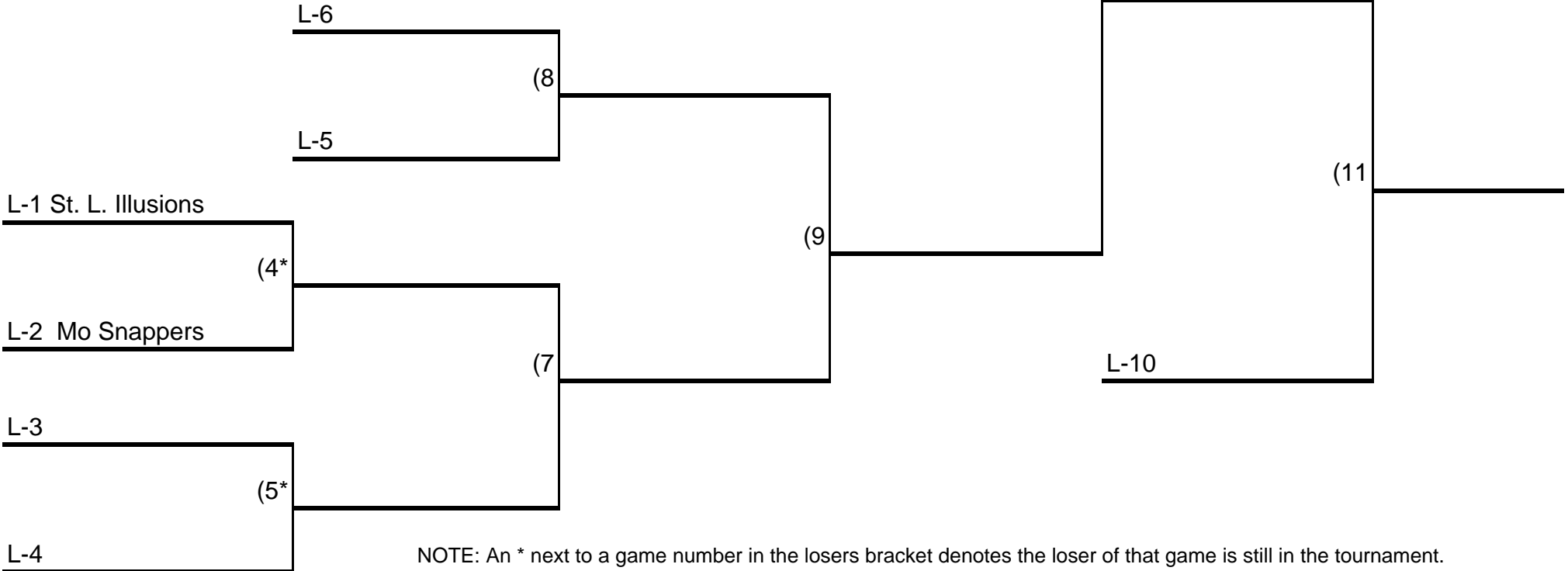

NOTE: An * next to a game number in the losers bracket denotes the loser of that game is still in the tournament.

SPIRIT CLASSIC - AFA

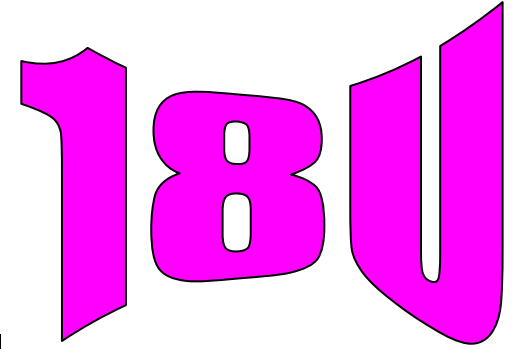

6 Teams - 3 Game Guarantee Bracket

SPIRIT CLASSIC - AFA

16A-18B

Winner's Bracket

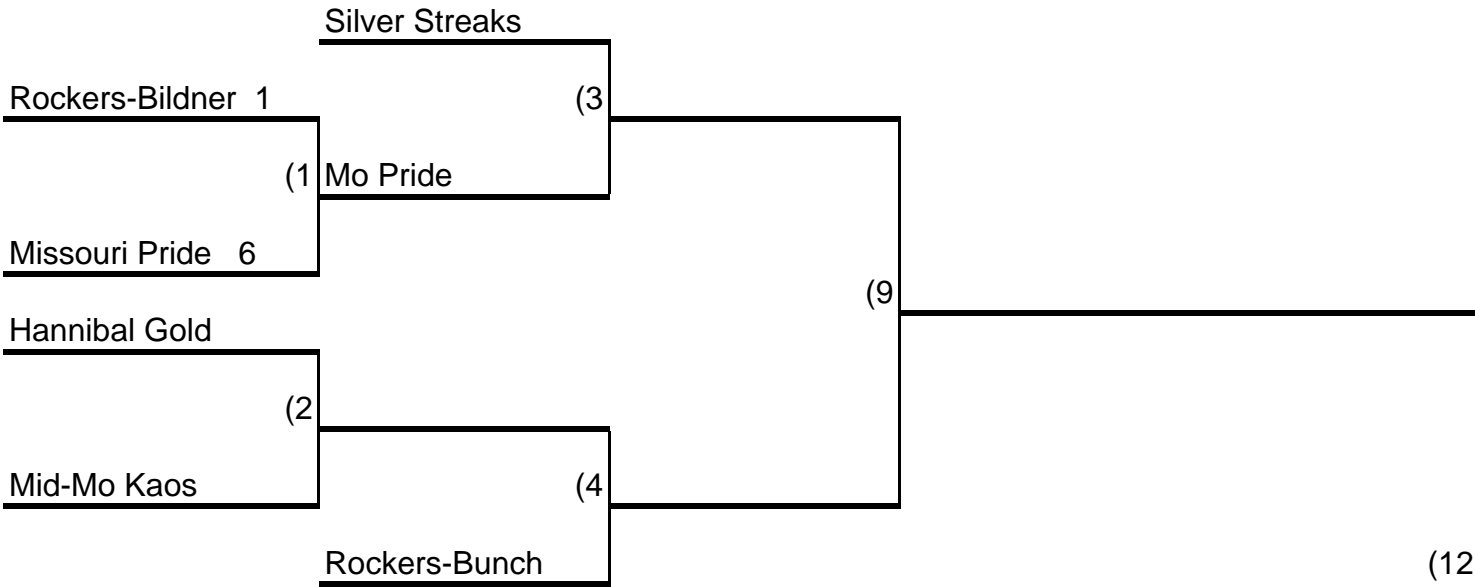

Loser's Bracket

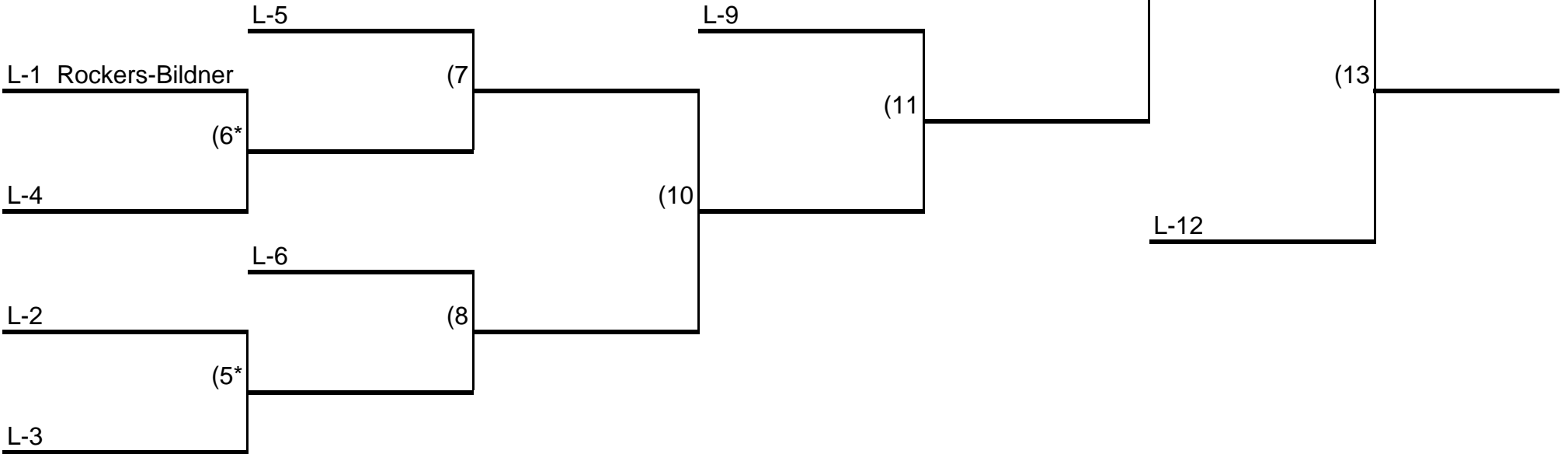

NOTE: An * next to a game number in the losers bracket denotes the loser of that game is still in the tournament.

4 Teams - 3 Game Guarantee Bracket

Winner's Bracket

Mid-M Renegades 0



Havoc 3



Loser's Bracket

L-1 Renegades



L-3

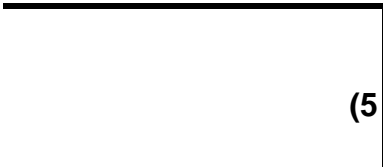

L-4

SPIRIT CLASSIC - AFA

16B-18B

Large purple stylized text with a white outline, positioned in the upper right area of the diagram.

(3)

(7)

(6)

(8)

L-7

NOTE: An * next to a game number in the losers bracket denotes the loser of that game is still in the tournament.

5 Teams - 3 Game Guarantee Bracket

SPIRIT CLASSIC - AFA

Winner's Bracket

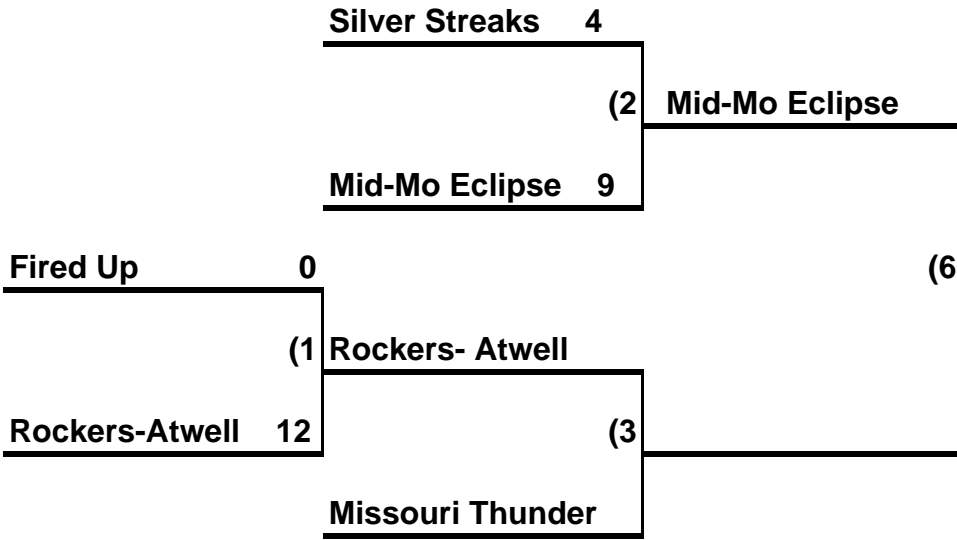

Loser's Bracket

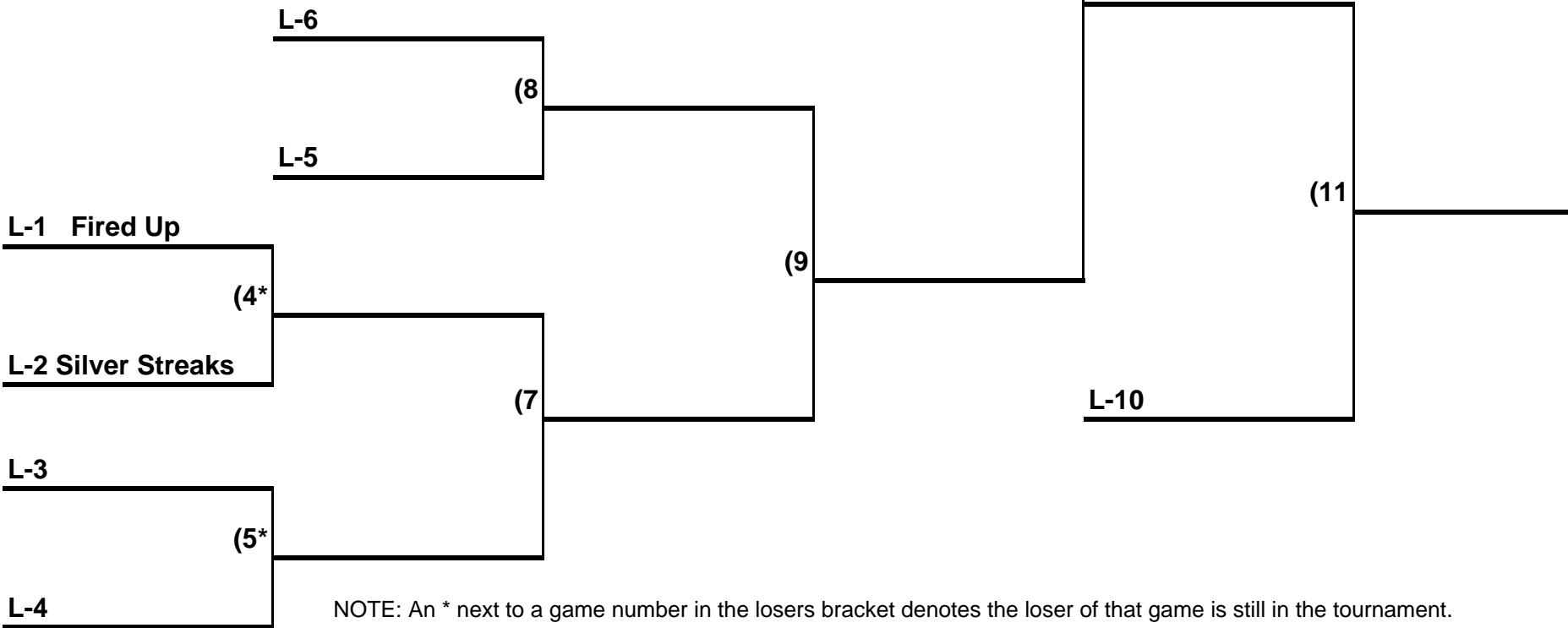

NOTE: An * next to a game number in the losers bracket denotes the loser of that game is still in the tournament.

6 Teams - 3 Game Guarantee Bracket

SPIRIT CLASSIC - AFA

Winner's Bracket

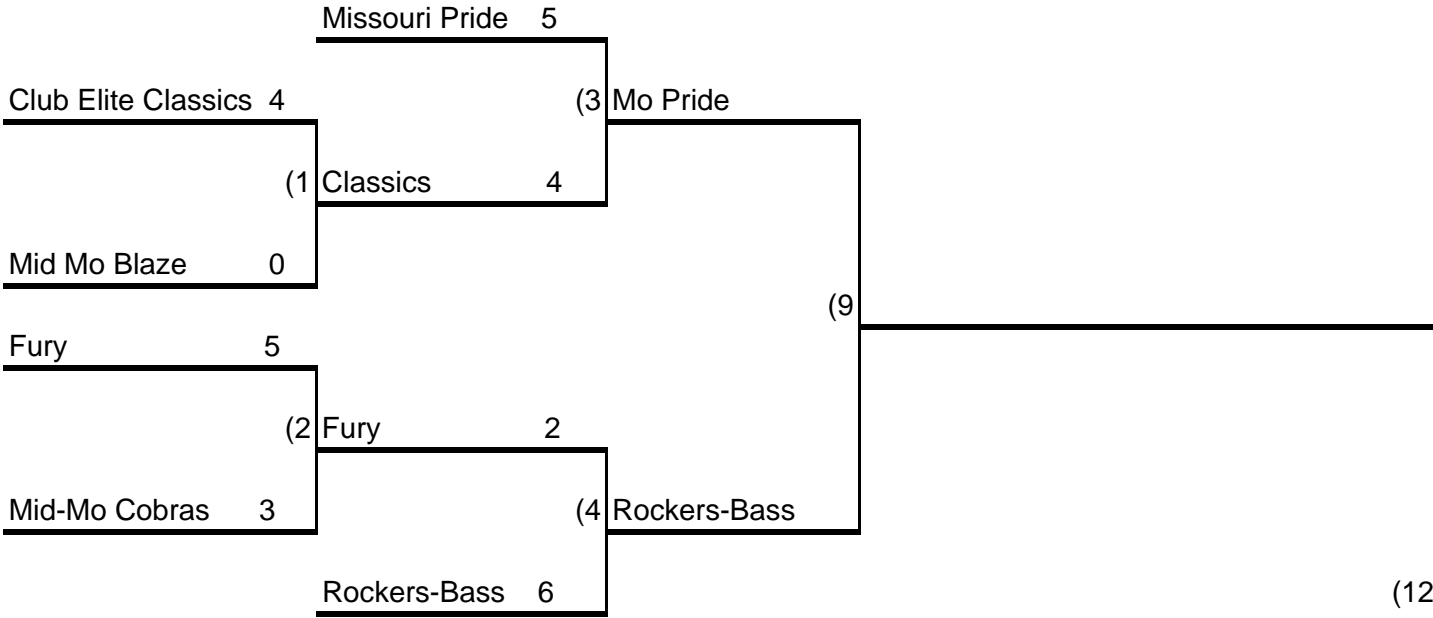

Loser's Bracket

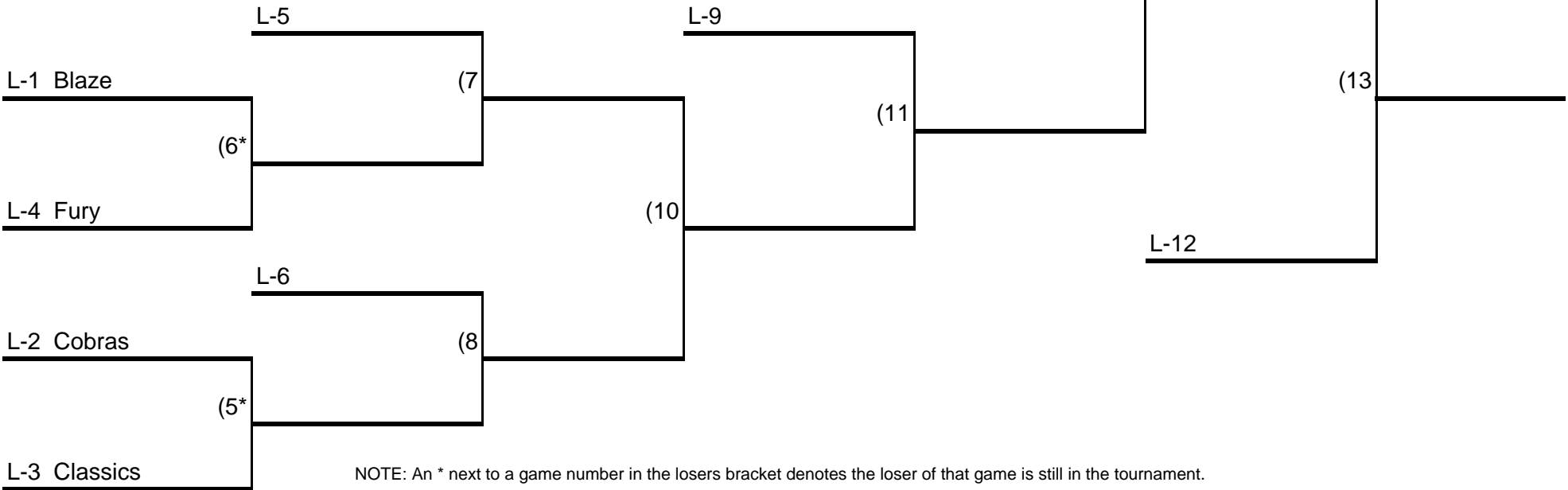

NOTE: An * next to a game number in the losers bracket denotes the loser of that game is still in the tournament.

5 Teams - 3 Game Guarantee Bracket

SPIRIT CLASSIC - AFA

Winner's Bracket

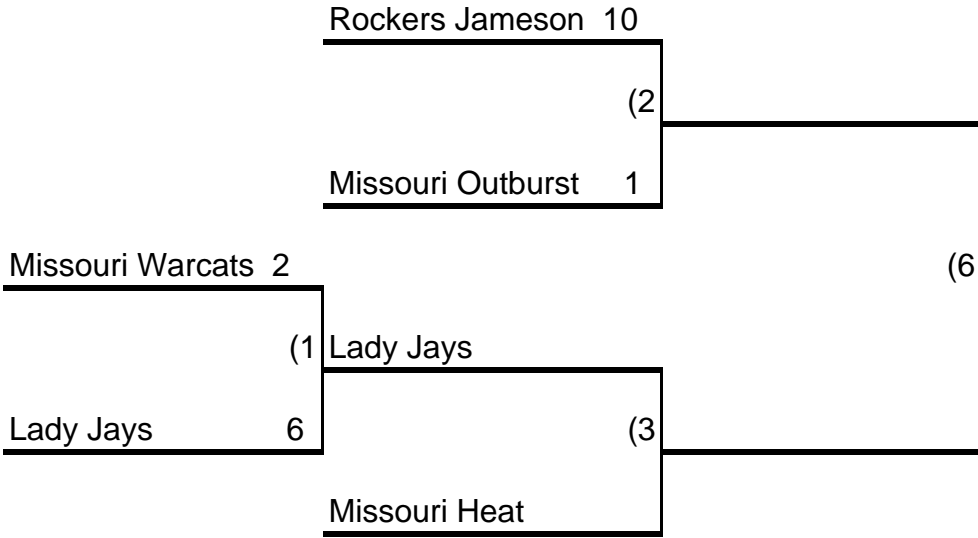

Loser's Bracket

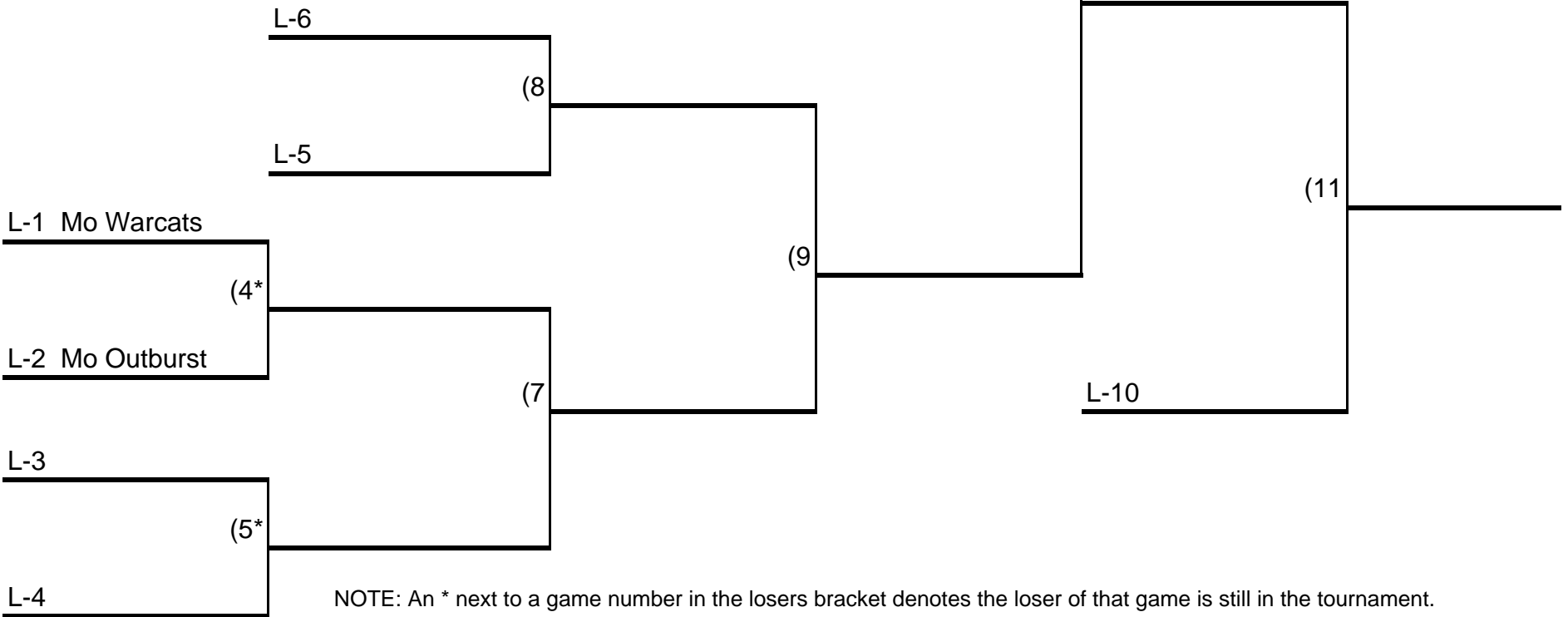

NOTE: An * next to a game number in the losers bracket denotes the loser of that game is still in the tournament.

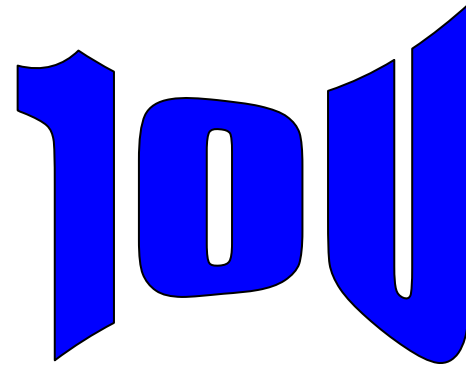

Revised May 31st 7:30 PM

Spirit Classic AFA National Qualifier
 Antimi Complex in Cosmo Park, Columbia, Missouri
 573-499-9741 - Rain Hotline

The 4:30 Games from Saturday will resume at 9:00 AM on Sunday
 Sunday Games will have 1 hour time limit.
 Championship Games will have 75 Minute Time Limit

Sunday	Sunday, June 1st					
1-Jun	Antimi Purple	Antimi Blue	Antimi Red	Antimi Green	Antimi Gold	Antimi Black
9:00	14u Gm 3	10u Gm 3	14u Gm 4	16A/18B Gm 2	16B/18B Gm 3	18A Gm 3
10:15	12u Gm 5	10u Gm 4	12u Gm 6	16A/18B Gm 3	16B/18B Gm 4	18A Gm 4
11:30	14u Gm 5	10u Gm 5	14u Gm 6	16A/18B Gm 4	16B/18B Gm 5	18A Gm 5
12:45	12u Gm 9	10u Gm 6	16A/18B Gm 5	16A/18B Gm 6	16A/18B Gm 9	18A Gm 6
2:00	10u Gm 7	12u Gm 7	14u Gm 7	12u Gm 8	16B/18B Gm 6	18A Gm 7
3:15	10u Gm 8	12u Gm 10	14u Gm 8	16A/18B Gm 7	16A/18B Gm 8	18A Gm 8
4:30	10u Gm 9	12u Gm 11	14u Gm 9	16A/18B Gm 10	16B/18B Gm 7	18A Gm 9
5:45	10u Gm 10	12u Gm 12	14u Gm 10	16A/18B Gm 11	16B/18B Gm 8	18A Gm 10
7:00	<i>10U if</i>	<i>12U if</i>	<i>14U if</i>	16A/18B Gm 12	<i>16B/18B if</i>	<i>18A if</i>
8:15	X	X	X	<i>16A/18B if</i>	X	X

Pool A - 10U	Pool B - 12U
--------------	--------------

- | | |
|---------------------|-----------------------|
| 1 Rockers-Jameson | 1 Missouri Pride |
| 2 Missouri Heat | 2 Rockers-Bass |
| 3 Missouri Outburst | 3 Club Elite Classics |
| 4 Missouri Warcats | 4 Mid-Mo Cobras |
| 5 Lady Jays | 5 Mid Mo Blaze |
| | 6 Fury |

Pool C - 14U	Pool D - 16B/18B 40'
--------------	----------------------

- | | |
|------------------------|----------------------|
| 1 Silver Streaks | 1 Mid-Mo Renegades |
| 2 Missouri Thunder 12u | 2 HAVOC |
| 3 Mid-Mo Eclipse | 3 Rockers-Perrigo |
| 4 Fired Up | 4 Mid-Missouri Blaze |
| 5 Rockers-Atwell | |

Pool E - 16A/18B 40'	Pool F - 18A 43'
----------------------	------------------

- | | |
|-------------------|-------------------------------|
| 1 Silver Streaks | 1 St. Louis Esprit-K |
| 2 Rockers-Bunch | 2 Macon Travelers |
| 3 Rockers-Bildner | 3 Missouri Renegades Gold |
| 4 Mid-Mo Kaos | 4 Missouri Snappers |
| 5 Missouri Pride | 5 St. Louis Illusions-Bergman |
| 6 Hannibal Gold | |

AFA National Qualifier - Columbia

This tournament will be 1 Tune Up; then 3 Game Guarantee Bracket Play.

All teams may bat roster in the Tune Up Games, Bracket Games will be full AFA Rules of Play

Coaches - Here is your checklist of things to do:

- 1) Coaches check in at Registration table 1-hour before your 1st game at the Concession stand where you game will be.
- 2) You will need the following
 - a) Team roster
 - b) Birth Certificates must be X
 - c) Proof of Team Insurance
 - d) AFA registration number
- 3) Teams will provide game balls that meet AFA specifications.
Deliver one game ball acceptable to the umpire at the coin flip of each game
(you do not have to provide a new ball each game).
- 4) In case of rain, call 573-499-9741 (coaches only please!) This is not a high volume answering machine!**
- 5) First and second place teams in each age division will be awarded individual trophies..
First place team will receive a berth and plaque

This is a AFA sanctioned tournament and all teams are required to be registered with AFA.

If your team is NOT registered with AFA yet, you must register by Friday : <http://www.afasoftballregion6.com/>

TOURNAMENT RULES AND INFORMATION

- 1) AFA rules will govern the tournament with the exceptions:
 - a) Time Limit: 75 minutes on all games
 - b) Run Limit: 12 run lead after 3 innings, 10 run lead after 4 innings, or an 8 run lead after 5 innings will end the game.
 - c) Tune Up games will may end in a tie; All Bracket Games will be played out.
 - d) A coin flip will determine the HOME team. Game time begins at the time of the coin flip.
- 4) Head Coaches are responsible for the conduct of their players, coaches, parents and fans.
- 5) Team chants and chatter may only be directed at your own team.
Phrases such as "swing batter", "Hit It to Me", or "Strike Out Batter", will not be allowed.
- 6) Absolutely No infield practice on playing fields. You may give ground balls behind the bases near the outfield.
Pitchers and catchers must warm up in FOUL territory
- 7) The official score keeper will be the scorekeeper of the home team.
The umpires will report the scores to the tournament director, however, both teams are responsible for checking the results, which will be posted at the tourney headquarters.
- 8) No protest on judgment calls, only rule interpretation
- 9) In case of rain it is the responsibility of the coaches to obtain their game times for the modified rain schedule.

Steve Hirt
573 - 424-7908

Gary Ennis
573-442-1117
573-489-1118

Debbie Jameson
573-424-9013 Mobile
573-499-9741 Office

Ron McMillan, UIC
573-819-5915